



Architects and
constructors
of musical
instruments

Experience the Sound of Quality

Manual

Symphonic Generation II Timpani



Preface

Contents

Thank you for choosing Adams Symphonic Generation II Timpani. We hope that you will gain pleasure and enjoyment from your new instrument, and we are confident that it will bring you many years of musical satisfaction. All Adams Musical Instruments are cleverly designed to the smallest detail, and are constructed with care and the highest levels of craftsmanship in Thorn, Holland.

Symphonic Generation II Timpani suit today's rigorous requirements for sound and durability. In addition to the precision tone adjustment provided by the block pedal and fine tuner, the newly improved support ring, counter hoop, and struts draw maximum sustain from the three different types of Adams timpani kettles. Symphonic Generation II Timpani give players extraordinary control of their sound.

In this manual, each feature is given brief description of how the feature works and a step-by-step adjustment guide. Understanding the adjustment is as important as making the adjustment.

At the factory, a new Remo Renaissance head is installed on all Adams timpani. During shipping and delivery, this head will stretch and settle. Before using your timpani for the first time, read and work through pages 4-9 to correct any mechanical difficulties caused by the change in the head tension. If necessary, general troubleshooting topics are available on pages 17.

Adams Musical Instruments are the choice of world-class soloists, orchestras, educators, and composers because of the firm's continued dedication to producing the finest sounding instruments possible through innovation and superior craftsmanship. Andre Adams, the company's founder, began repairing brass instruments in 1971, and gained experience as an instrument maker with many well-known firms in Europe. Music was his hobby, engineering his passion. The importance of scientific innovation in establishing production quality and continuity, along with important relationships with top professional and amateur musicians, has led the company to emerge as one of the world's largest percussion instrument manufacturers. Adams' corporate vision is passion for music: creating instruments by musicians, for musicians. Experience Adams—Experience The Sound of Quality.

3	Nomenclature
4	Fundamental Tone
6	Pedal System
8	Tuning Gauge
10	Fine Tuner
12	Range Selector
14	Head Replacement
16	Clearing Heads
17	Troubleshooting
18	Use and Care
20	Specifications
21	Warranty
22	Accessories

Scan this QR code to check for the latest version of this manual, or visit: www.adams.nl/manuals/



Nomenclature

Symphonic Generation II Timpani

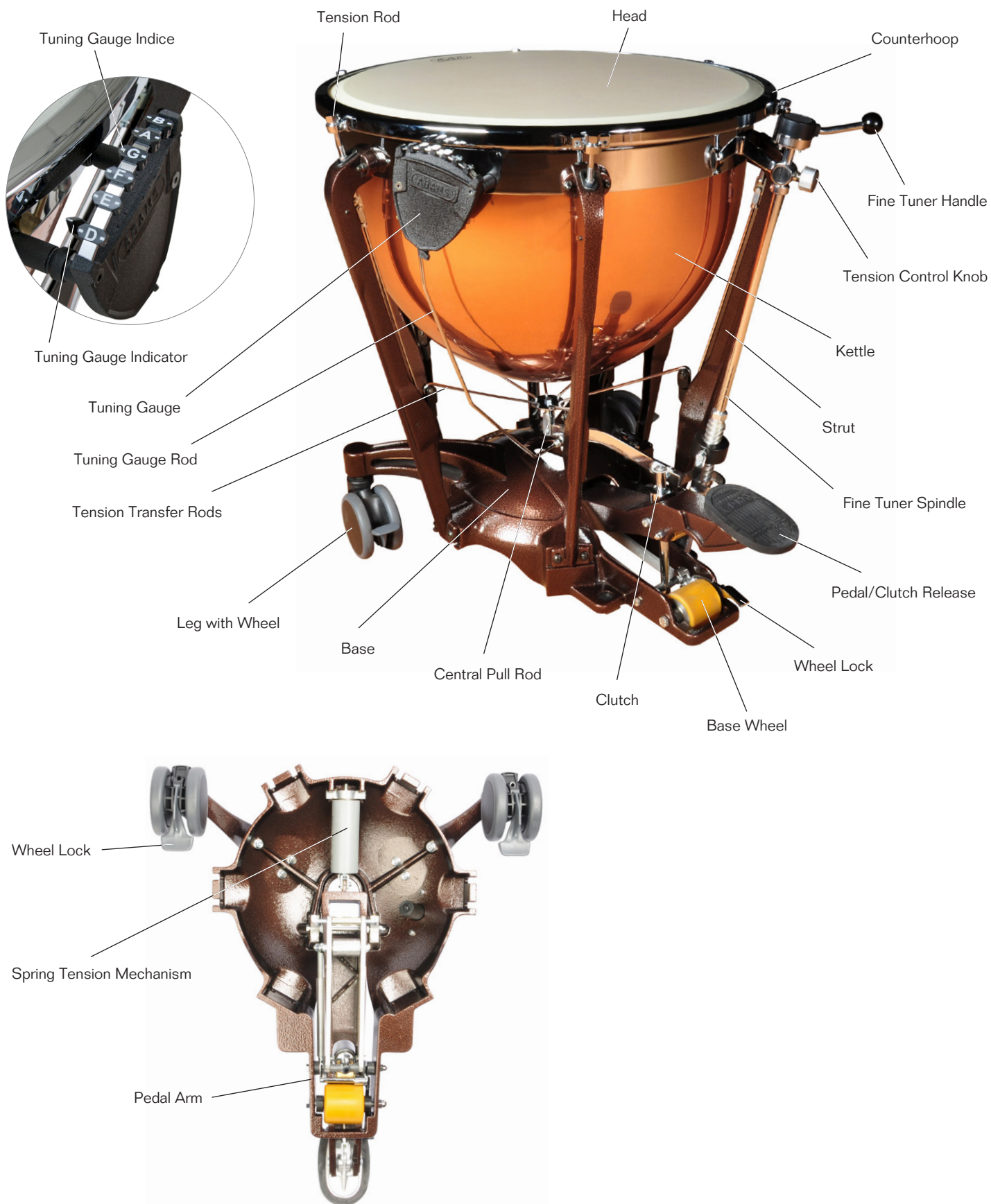

Fundamental Tone

Overview

Timpani are machines: mechanical parts work together to allow the player to change the tone of the instrument by means of a pedal, a fine tuner, or by both mechanisms. The pedal and fine tuner apply uniform tension to all of the tension rods at the same time.

Each timpani has a specific scalar range, and the lowest tone of this range is called the fundamental tone. The fundamental tone is set by the individual tension rods when the pedal is in the position of the lowest tone. The correct fundamental tones for Adams Symphonic Generation II Timpani are listed below.

Fundamental Tone: Symphonic Generation II Timpani

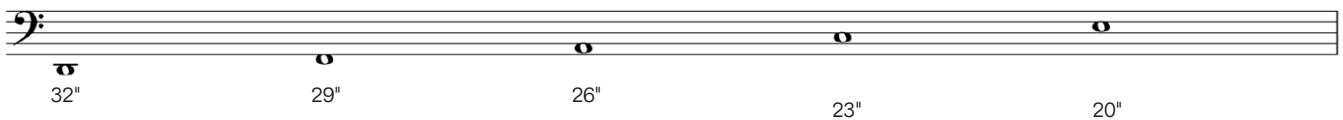

The pedal has a specific range of mechanical motion. Moving the pedal applies tension to the fundamental tone and produces the scalar range of each individual timpani.

Scalar Range: Symphonic Generation II Timpani

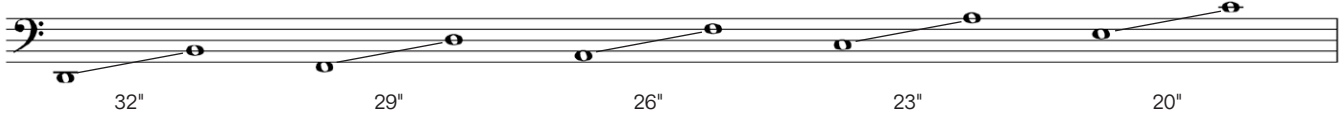

Adjustment

The head tension interacts with the mechanical balance. The correct fundamental tone is the most important factor in determining correct mechanical function. When the fundamental is correct, the pedal has a full range of mechanical motion, achieves the correct scalar range, and functions correctly. When the fundamental tone is too low or too high, the head tension will not work with the mechanical system: the pedal will not work correctly and the scalar range will be limited.

Symphonic Generation II Timpani have a fine tuner. It is important to use the individual tension rods to tune the fundamental tone. Using the fine tuner to correct the fundamental will decrease the fine tuner function and affect the pedal feel.

Process

- 1 Move the pedal to the position of the lowest tone.
- 2 Move the fine tuner to the lower third of its mechanical range. In this position, the black bracket will be positioned in the lower third of the spindle thread.

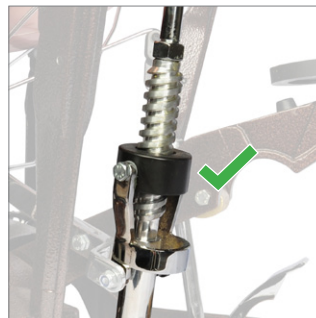
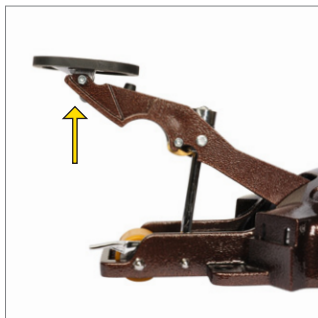

See pages 10-11 for detailed information regarding fine tuner operation.

- 3 Confirm that the collar is even on each side of the kettle. Adjust as necessary.

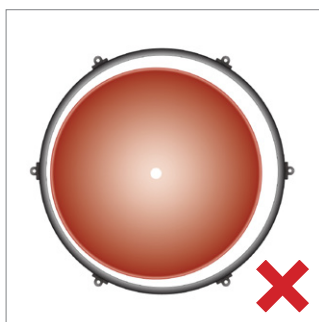
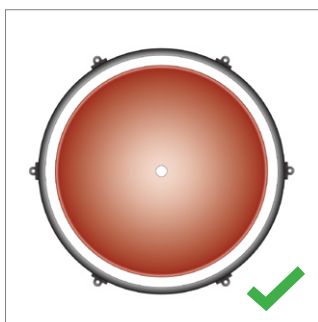

- 4 Use a tuning fork or other tuning device as a tone source. Play the fundamental tone and compare to the list on page 4.

- 5 If the tone is not correct, adjust to the correct fundamental tone.

- Make equal adjustments to each tension rod (half or quarter turns) in the order demonstrated in the picture.
- Evaluate the tone after each complete round of adjustment. Continue to adjust as necessary until the fundamental tone is correct.

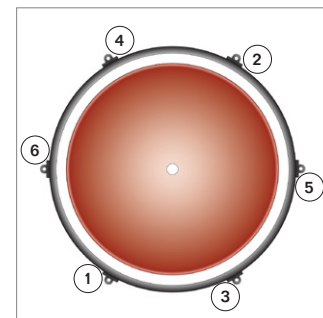
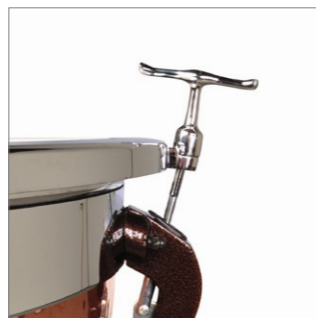

- 6 Maintenance

As a head stretches, the fundamental tone will become lower. The head will need to be adjusted according to the above process. Eventually, a plastic head can and will stretch to the point that it cannot provide the resistance necessary to return the pedal to the lowest tone. The head will then need to be replaced to restore proper function.

Adams recommends changing heads once every two years to ensure correct mechanical function, or more often if the quality of the tone deteriorates.

Pedal System

Overview

The Symphonic Generation II block pedal system securely locks pedal adjustments into place. The pedal system has two key factors: the clutch that locks adjustments in place, and the mechanical resistance provided by the head tension.

Raising the tone

The clutch does not have to be released to raise the tone. Simply apply pressure to the pedal to raise the tone.



Lowering the tone

Press the toe of the pedal to release the clutch and lower the tone. The pedal will automatically move from higher tones to lower tones.



Tension rods and the fine tuner determine the head tension. The head tension interacts with the pedal system, providing the mechanical resistance that moves the pedal from the higher tone to the lower tone.

When the fundamental is correct, the pedal achieves the correct scalar range. The tension from the head is strong enough to move the pedal from the highest tone to the lowest tone.



When the fundamental is tuned too low, the pedal will not return to the lower range. In this case, the tension from the head is not strong enough to fully move the pedal from the highest tone back to the lowest tone.



Adjustment

The pedal system functions correctly when the fundamental tone correct. If the fundamental tone is not correct, the pedal will not return to the position of the lowest tone.

Process

1

If the pedal system is not functioning correctly, first confirm the correct fundamental tone as described on page 5.

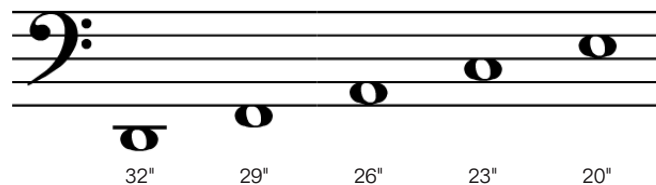

2

Check the adjustment: Move the pedal and see if the function has changed.

- If the pedal returns to the position of the lowest tone, the system is functioning correctly.
- If the pedal still does not return to the position of the lowest tone, proceed to step 3.

3

Change the head

As a head stretches, the fundamental will need to be adjusted according to the above process. A plastic head can and will stretch to the point that it cannot provide the resistance necessary to return the pedal to the lowest tone. The head will then need to be replaced to restore proper function.

Adams recommends changing heads once every two years to ensure correct mechanical function, or more often if the quality of the tone deteriorates.

Tuning Gauge

Overview

A timpani gauge is a display of the pedal's mechanical position: it is not a measure of the tone that the instrument produces when played.



Adjustment

The pointer position, range of motion, and individual indice letters must all be adjusted for the tuning gauge to function correctly.

Process

1

Confirm the correct fundamental tone as described on page 5.

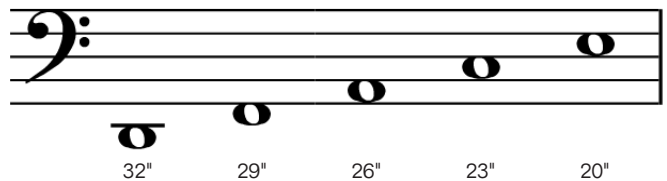

2

Set the distance of the pointer from the gauge.

- Move the pedal to the position of the lowest tone.
- Set the pointer to the desired distance from the gauge and the position of the lowest tone. Secure in place with the wing screw.

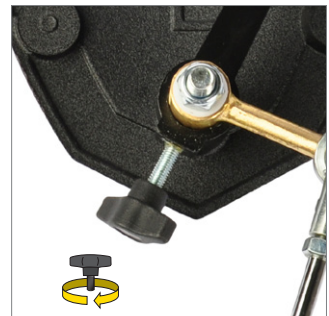

3

Set the range of motion.

- Move the pedal to the position of the lowest tone.
- Move the pedal through the scalar to view the distance that the pointer moves. Determine if more or less distance is necessary in the range in the motion.
 - For more distance, move the fitting towards the axel.
 - For less distance, move the fitting toward the tip.

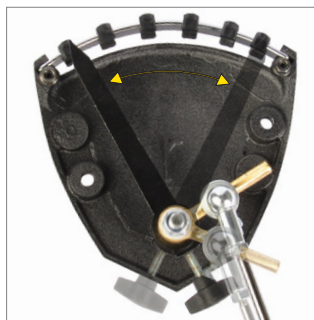

4

Adjust the letters: set all similar tones (identical and octaves) before moving to another tone. Begin with **A2**.

- 4.1 Tune **A2** on the 29" timpani. *Set the 29" A indice.*
- 4.2 Tune **A2** on the 26" timpani and match it to the 29".
Set the 26" A indice.
- 4.3 Tune **A3** on the 23" timpani, one octave higher than **A2**. Begin with the tone source, and tune with the octave **A2** on the 29".
Set the 23" A indice.
- 4.4 Tune **A3** on the 20" timpani, and match it to the 23".
Set the 20" A indice.
- 4.5 Repeat steps 4.1-4.5 with B, C, D, E, F, G: match identical tones and octaves.



Use a tuning fork or other tuning device as a tone source.

5

Maintenance

A head will stretch over time, lowering the fundamental tone. The tuning gauge will become inaccurate when this happens. Restore correct tuning gauge function by correcting the fundamental tone of the head as described on page 5.

If moving the letters is required after correcting the fundamental tone, the letters will usually end up with very little space between the letters as demonstrated in the incorrect picture. When this happens, the head has stretched to the point that it needs to be replaced.

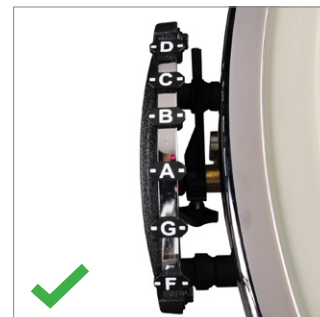

Fine Tuner

Overview

A timpani pedal applies pressure to all of the tension rods at the same time. The fine tuner does the same thing in smaller and more precise increments, giving the player precise intonation control. A fine tuner is standard on all Adams Symphonic Generation II Timpani.

The fine tuner operation is smooth and simple. After either raising or lowering the pitch, lift the lever and return it to the opposite side to make further adjustments as necessary. The fine tuner holder bracket has a tension control knob that is used to prevent back spin.

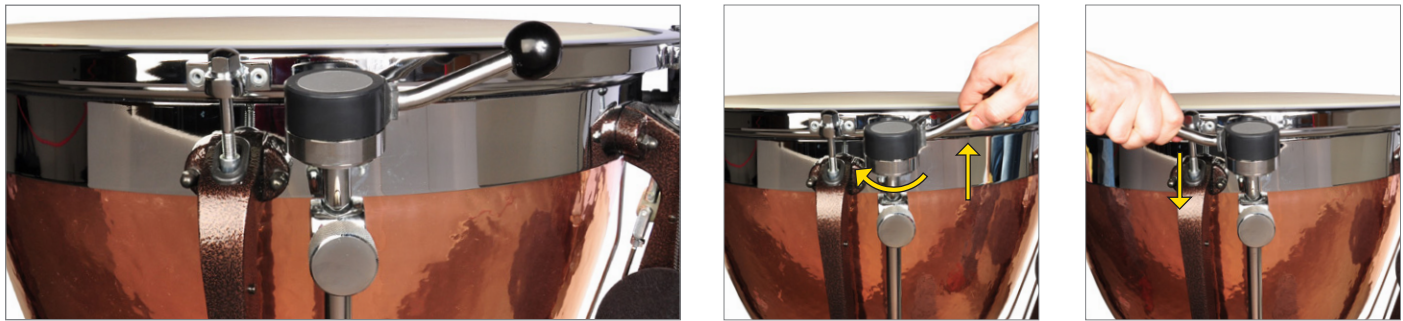

Like the pedal mechanism, the fine tuner has a mechanical range of motion. For correct function, the fine tuner must be positioned near the lower third of its mechanical range. This position allows the player to either raise or lower the tone. When the fine tuner is in either the highest or lowest mechanical position, the fine tuner will not have full function: the player will not be able to both raise and lower the tone.

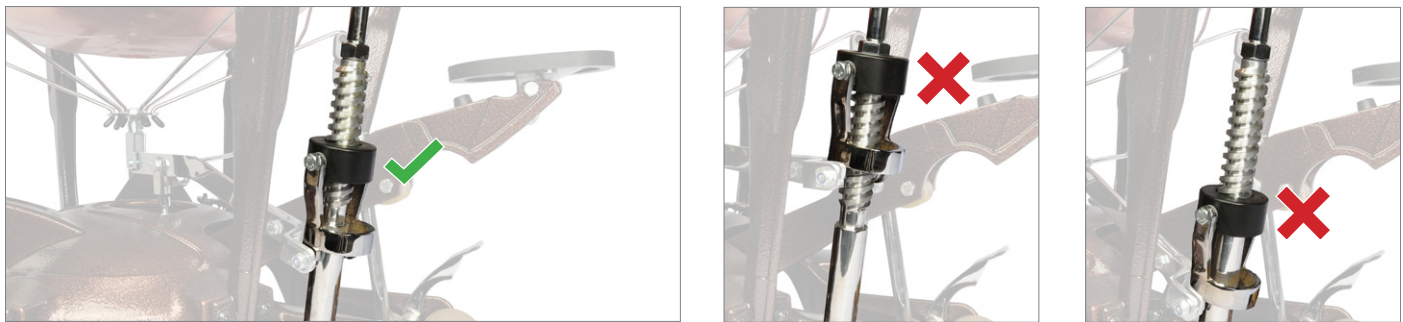

Adjustment

Timpani with fine tuners have two mechanisms that set the fundamental tone: the tension rods and the fine tuner. The relative amount of tension applied by each of these mechanisms determines the amount of resistance in the pedal motion. If these two factors are out of balance, the resistance in the pedal feeling is affected and the fine tuner will not have full functionality.

Process

1

If too much tension is applied by the fine tuner compared to the tension rods, the pedal resistance is high. This occurs when the fine tuner is in the highest mechanical position. In this position, the player can only use the fine tuner to lower the tone.

- Move the fine tuner to the lower third of the range.
- The fundamental tone must now be tuned higher. Correct the fundamental tone with the tension rods as described on page 5.

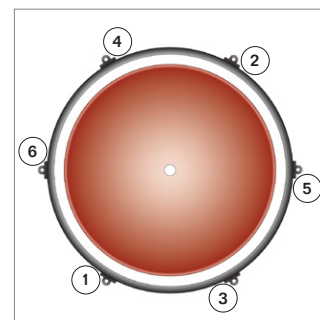
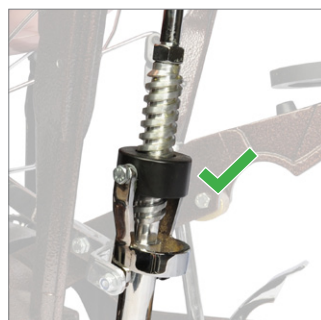
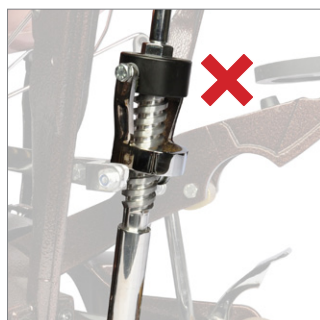

2

If too little tension is applied by the fine tuner when compared to the tension rods, the pedal resistance is low. This occurs when the fine tuner is in the lowest mechanical position. In this position, the player can only use the fine tuner to raise the tone.

- Move the fine tuner to the lower third of the range.
- The fundamental tone must now be tuned lower. Correct the fundamental tone with the tension rods as described on page 5.

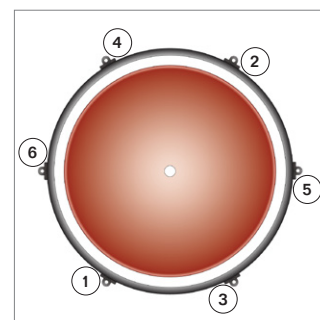
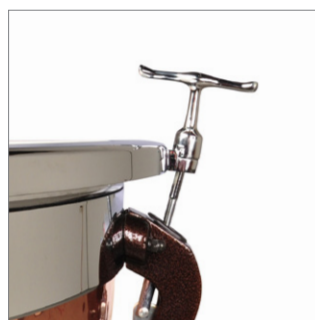
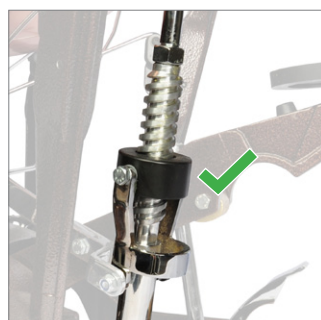

4

Maintenance

As the head stretches, it is important to correct the fundamental tone with the tension rods. It is faster to make this adjustment with the fine tuner, but doing this will eventually move the fine tuner to the end of its mechanical range and negatively affect pedal performance.

Range Selector

Symphonic Generation II Timpani have a mechanical range that produces a scalar range of a musical 6th (see diagram on page 4). The fine tuner can easily select a fundamental tone that is either lower or higher than normal. Changing the fundamental tone allows the player to select a range of a 6th from within an octave of tonal range.

Example:

A 29" with a F2 fundamental tone has a range from F2-D3.

- Adjusting the fundamental tone higher to G2 produces a range from G2-E3

- Adjusting the fundamental tone lower to E2 produces a range from E2-C3

- The total available range to select from is an octave, E2-E3.

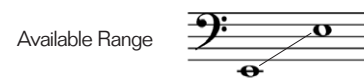
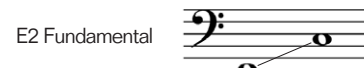
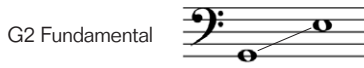
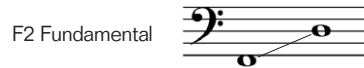

In addition to giving each size a larger range to choose from, using the fine tuner as a range selector also increases the overlap in ranges between sizes. This can allow a player to not bring a specific size to a gig. For example, if a 23" timpani is only needed for a G3 tone, the 26" range can move from A2-F3 to B2-G3 to play the G3 if the music allows.



Process

1
Move the pedal to the lowest tone.

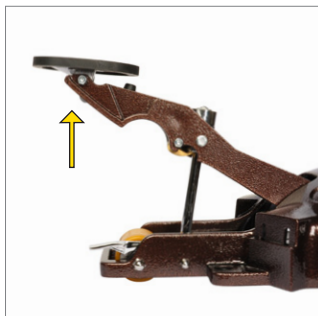

2
Use the fine tuner to select the new fundamental tone.



3
Changing the fundamental will change the accuracy of the tuning gauge.

- If the adjusted fundamental is necessary for an extended period of time, adjust the indicator position and letters.
- If the adjusted fundamental is necessary for a short period of time, make changes only as necessary.

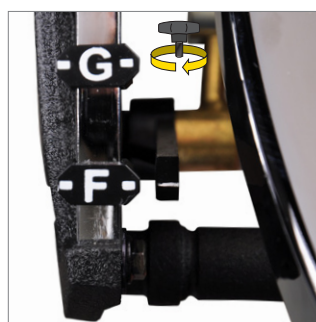

Head Replacement

Overview

Adams recommends changing heads once every two years to ensure correct mechanical function, or more often if the quality of the tone deteriorates.

Timpani head sizes are not the same as the size of the kettle. Head sizes are equal to the size of the kettle added to the total size of the collar. Refer to the chart below for the correct head sizes for Adams Symphonic Generation II Timpani.

TIMPANI SIZE	32"	29"	26"	23"	20"
HEAD SIZE	34" Remo Size: 3400	31" Remo Size: 3100	28" Remo Size: 2800	25" Remo Size: 2500	22" Remo Size: 2200

Process

1
Lock all wheels.



2
Move the fine tuner to the lower third of its mechanical range. In this position, the black bracket will be positioned in the lower third of the spindle thread.



3
Move the pedal to the lowest tone.



4
Remove tension rods.

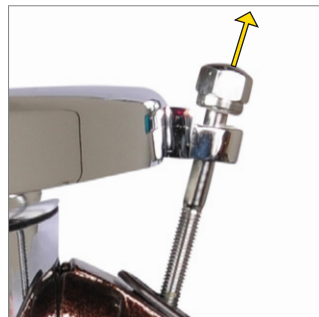

5
Remove the counter hoop and head. Clear any dust or debris that may have accumulated under the counter hoop.



6
Head installation is an excellent time for routine maintenance. Please see the "Cleaning and Lubrication" sections of "Use and Care" on pages 18-19 for recommended maintenance during head installation.

7

Place a new head on the kettle with the logo opposite the pedal. Start each tension rod with only 1-2 turns.

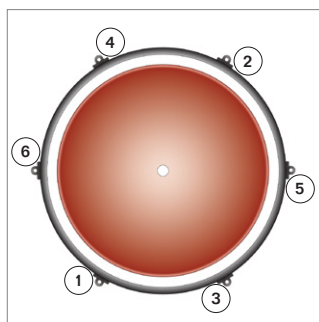
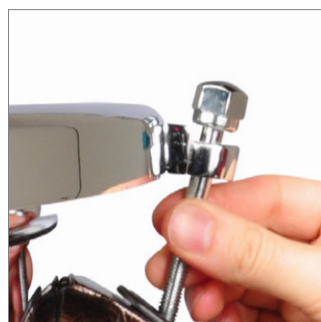

8

Center head on kettle. Confirm even collar on each side of the kettle.

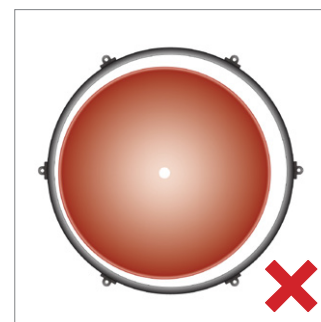
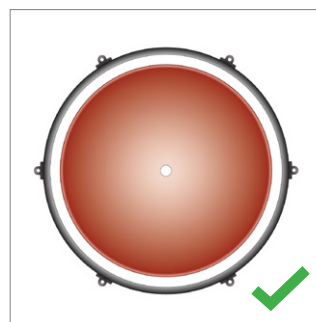

9

Apply initial tension to the head. Hold the tension mechanism on each strut tight as tension is applied. Engage each tension rod to the point where it just begins to apply pressure to the head. Each of the tension mechanisms in the struts must be equally spaced from the center pull rod to ensure that the collar is even. Use the tension pattern from Step #7 when adjusting the tension mechanisms and seating the head.

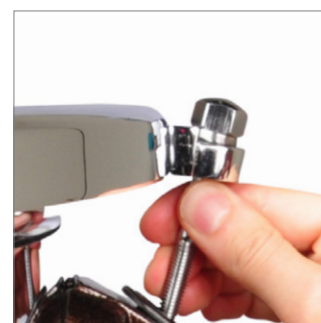
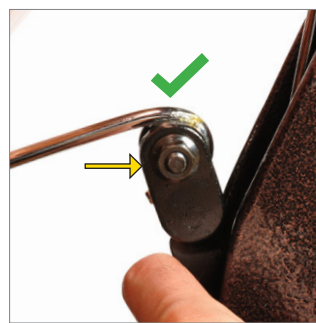
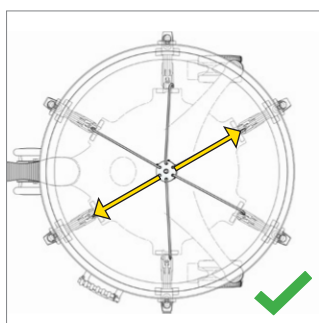
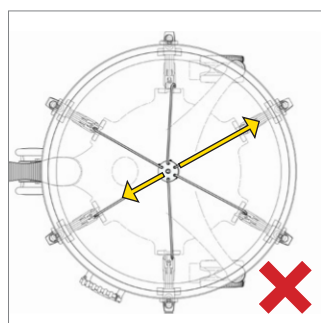

10

Tune fundamental tone as described on page 5.

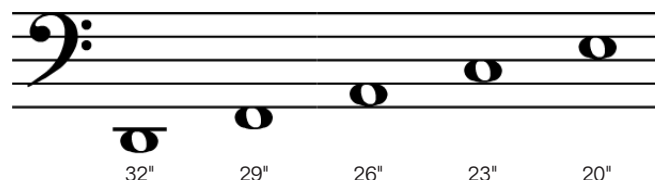

11

Place the pedal in the position of the highest tone. Keep the pedal in this position for 48 hours. The head will stretch during this time. Afterwards, correct the fundamental tone with the tension rods.

12

Set the tuning gauge as described on pages 8-9.

13

After the head has stretched, unevenness in the tone may be cleared if necessary.

Clearing Heads

Overview

"Clearing heads" refers to the process of accurately tensioning each tension rod to achieve a perfectly clear tone.

Do not use an electronic tuner to attempt to get each tension rod in tune. An electronic tuner will pick up all the tones occurring in the head, and it is not able to isolate the sound coming from each individual tension rod. Using a tuner on each individual tension rod is like trying to tune one harp string while strumming all the strings at once. The only way to isolate the sound coming from each individual tension rod is by using the human ear.

Adjustment

Head clearing must be done in a quiet environment and only for ten minutes at a time. The ear fatigues quickly; attempts to work for long periods of time will produce incorrect results. Make one or two small adjustments that are absolutely correct and continue again at a later time. There are many ways to clear timpani heads. Below is the most basic process.

Process

1

Tune the head to a tone in the middle of the range. Place an Adams timpani mute in the center of the head.

2

Put your ear against the counter hoop and play the head two inches in front of a tension rod with a very hard stick and soft stroke. Play three quick strokes and listen to the tone at a tension rod. Move to the two adjacent rods and repeat. Focus only on the lowest fundamental tone you can hear; do not listen to any high harmonics.

3

Make note of the tension rod that sounds extremely flat or sharp and focus on it first. Raise or lower the tone of that tension rod by one quarter turn accordingly until the tone more closely matches the tone of the tension rod to the immediate right and left. Focusing on one tension rod and its two adjacent tension rods at a low volume is best.

4

Repeat step #3 and work around the head in a clockwise motion. With effort, the heads can be cleared from inconsistencies.



Troubleshooting

During normal use, all timpani require need minor adjustments to maintain correct working order.

As discussed in previous sections, the correct fundamental tone is the most important factor in maintaining excellent working order. Because a head naturally stretches, regularly checking the fundamental tone and correcting as necessary is highly recommended. Almost all troubleshooting begins with correcting the fundamental tone.

HEAD/PEDAL	Refer to Pages
Symptom: The fundamental note gradually becomes lower over time. Diagnosis: All heads stretch, slowly lowering the fundamental tone. Action: First set the fundamental tone, then adjust the spring tension if necessary.	4-5 6-7
Symptom: The pedal does not return to the lowest position when the clutch is released. Diagnosis: Either the fundamental incorrect or the head needs to be changed. Action: Check the fundamental tone, and then reevaluate the pedal performance. If this does not correct the problem, change the head.	4-5 6-7 10-11 14-16
Symptom: The timpani does not achieve the correct scalar range. Diagnosis: The fundamental must be corrected or the head needs to be replaced. Action: Check the fundamental tone, and then reevaluate the pedal performance. If this does not correct the problem, change the head.	4-5
Symptom: The quality of the tone produced has decreased. Diagnosis: The head is played out: denting in the head is probably visible when the timpani is tuned to the lowest tone. Action: Change the head.	14-16
Symptom: The head is not centered. Diagnosis: The collar is uneven. Action: Loosen tension in head, move collar, check tension mechanism in strut, and retune fundamental tone.	4-5 14-15
Symptom: There is noise coming from the head when the pedal is moved. Diagnosis: The kettle bearing edge is not correctly lubricated. Action: Remove the head, remove old lubrication, and apply new lubrication.	18

TUNING GAUGE	Refer to Pages
Symptom: The tuning gauge indicator only moves a small distance. Diagnosis: The tuning gauge connection rod position on the axle is incorrect. Action: Adjust the position of the connection.	8-9
Symptom: The tuning gauge letters are not accurate. Diagnosis: Either the tuning gauge letters need to be set or the fundamental tone has lowered. Action: First correct the fundamental tone, then move the letters if necessary.	8-9
Symptom: The tuning gauge indicator does not move when the pedal moves. Diagnosis: Either the indicator or the connection rod is loose. Action: Find the loose connection and tighten as necessary.	8-9

FINE TUNER	Refer to Pages
Symptom: The pedal resistance is either very high or very low. Diagnosis: The fine tuner is at an extreme in its mechanical range. Action: Move fine tuner to middle of mechanical range and retune fundamental with tension rods.	10-11
Symptom: The fine tuner is not responsive. Diagnosis: The fine tuner is at an extreme of its mechanical range. Action: Move fine tuner to middle of mechanical range and retune fundamental with tension rods.	10-11

Use and Care

Overview

Timpani require routine care and maintenance. The small amount of necessary maintenance does not require a technician and can be a do-it-yourself project for any percussionist or band director.

Moving and Transport

1. Adams Symphonic Generation II Timpani feature integrated wheels for effortless moving. Always lock all wheels when the timpani are in use. The locks secure the timpani in place while the pedals are used. Always unlock all wheels before moving the instrument. Moving the instrument with the locks engaged will damage the wheel.
2. When lifting the timpani is necessary, including on stairs, sloped, or uneven surfaces, always lift the timpani by the struts with two people.
3. Never lift or push the instrument by the counter hoop, as this can cause the collar to become uneven and deform the head and counter hoop. Always push or lift by the struts.
4. When moving the timpani by vehicle, contain the instrument in a flight case or secure in place with strapping material. Do not lay the instrument on its side, as this can damage the struts, support ring, counter hoop, head, and kettle. Horizontal transport can cause the kettle to become out of round and will definitely cause the collar to become uneven.

General Care

1. Move the pedal to the lowest tone position after each use. If the fundamental is tuned correctly, the collar will not shift during normal transport.
2. Use a drop cover to protect from dust and use a head cover to protect the head from damage.
3. Avoid running the timpani into objects—walls, other instruments, etc. In addition to potential damage to the instrument, the collar may become uneven.
4. Clean frame with a soft cloth and general purpose cleaner.
5. Clean kettle only as necessary: Only use a slightly wet, soft cotton cloth to remove debris. Using any type of glass cleaner or abrasive cleaner will remove the lacquer and cause discoloration to the kettle.
6. Polish chrome: Use a soft polishing cloth and polishing cream to clean and polish chrome parts. Pay close attention to polishing the counter hoop, as it often comes in contact with the sweat from hands during playing and transport.

Cleaning and Lubrication

1

Kettle bearing edge

Remove old lubrication with either #0000 steel wool or fine emery cloth (minimum P320).

Remove any debris with a clean, lint free cloth.

Apply new Teflon lubrication according to manufacturer's directions. Apply multiple layers of spray, allowing each layer to dry in between applications. Never use grease on the lip of the kettle. Grease on the head is bad for the sound of the instrument.



2
Tension rods

Remove old grease with mild cleaning agent on a soft cloth or #00 steel wool.



Remove cleaning agent with a slightly wet soft cloth.



Replace tension rod washer if necessary. (Washer part number PB418, quantity 1 each)



Apply small amount of multi-purpose lithium grease to tip of tension rod.

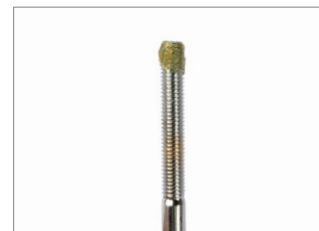

3
Tensioning mechanism: Use aerosolized lithium grease (not oil, WD40, or similar products) to direct lubrication into the following places as necessary. Always use a cloth to protect the instrument from overspray.

Axel pin in struts



Axel Pin in Strut



Pedal axel

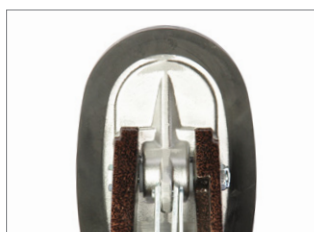

Pedal connection arm

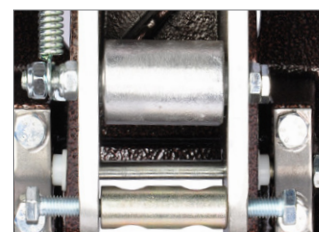

Fine tuner spindle



Spider

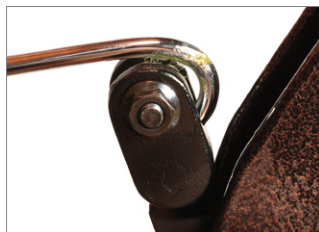

Spring Mechanism

⚠ DO NOT DISASSEMBLE THE SPRING TENSION MECHANISM.

The spring mechanism has been lubricated at the factory with a long lasting, high performance grease.

Disassembly will only cause problems that are not easily solved.

4
Tuning gauge mechanism: Use aerosolized lithium grease (not oil, WD40, or similar products) to direct lubrication into the following places as necessary. Always use a cloth to protect the instrument from overspray.

Linkage Joint

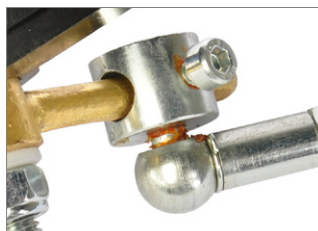

Indicator Axel



5
Replace head centering insulation as necessary. The foam insulation pieces center the head in the counterhoop, making it easier to have an even collar.

Insulation for 20/23/26: PT012
Insulation for 29/32: PT013

(Each part number is 1 piece of foam)



Specifications

Adams Symphonic Generation II Timpani
 PEDAL STYLE: Block Style
 CONFIGURATIONS: American and German
 TUNING GAUGE: Standard
 FINE TUNER: Standard
 KETTLE TYPES:

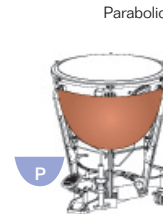

	32"	29"	26"	23"	20"
HEIGHT 	85 cm	85 cm	85 cm	85 cm	85 cm
LENGTH 	103 cm	99 cm	96 cm	89 cm	84 cm
WIDTH 	96 cm	88 cm	85 cm	77 cm	71 cm
RANGE	D2-B2	F2-D3	A2-F3	C3-A3	E3-C4
HEAD TYPE	Remo Renaissance -- Hazy Film with Aluminum Insert Ring				
HEAD SIZE	34" Remo Size: 3400	31" Remo Size: 3100	28" Remo Size: 2800	25" Remo Size: 2500	22" Remo Size: 2200

Specifications subject to change without notice

Warranty

Adams Musical Instruments is pleased to guarantee all Percussion Instrument for a period of one year from the original purchase date from your authorized Adams dealer.

This warranty specifically excludes:

- Wear from normal use
- Damage from neglect, abuse, accident, or improper maintenance
- Exposure to extremes in temperate or humidity
- Heads, Mallets, and Keyboard Bars

Adams Musical Instruments reserves the right to determine whether the asserted defects were caused by the above mentioned conditions or not. Please contact the authorized Adams dealer from which your instrument was originally purchased for warranty service. Warranty coverage may vary from country to country; please contact your dealer/distributor for relevant details.



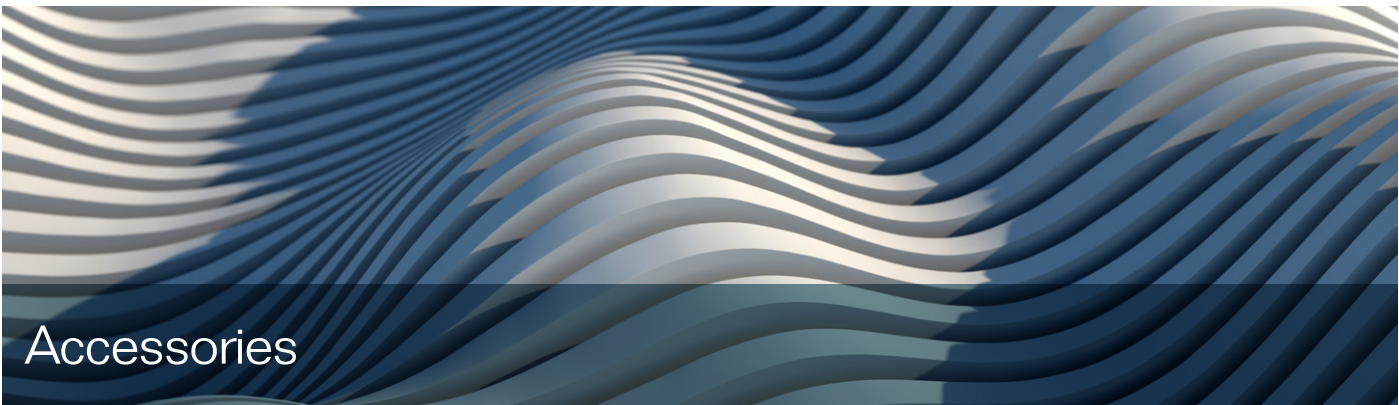

Accessories



Timpani

Birch



- Timpani Birch hard **TR1**
- Timpani Birch medium **TR2**
- Timpani Birch soft **TR3**

Maple



- Timpani maple staccato **TM0**
- Timpani maple hard **TM1**
- Timpani maple medium **TM2**
- Timpani maple soft **TM3**

Tonkin



- Timpani tonkin staccato **TT0**
- Timpani tonkin hard **TT1**
- Timpani tonkin medium **TT2**
- Timpani tonkin soft **TT3**

Classic Signature



- Bamboo cartwheel **CD1**
Very bright and brilliant
- Hickory cartwheel **CD2**
Bright
- Bamboo cartwheel **CD3**
Warm, Sonorous
- Hickory cartwheel **CD4**
Legato
- Bamboo ballstick **CD5**
Dark, Mellow
- Hickory cartwheel **CD6**
Soft, rich
- Bamboo ballstick **CD7**
Dark, Sonorous, Rich
- Hickory wood stick **CD8**
Extremely hard, Bright
- Hickory Flip stick **CD9**
Extremely bright to general
- Hickory Chamois stick **CD10**
Very brilliant to articulate



Scan this QR code for a full selection of Adams Mallets, or visit www.adams.nl/mallets/



4MTST
Table for Mallets and Accessories



4MLTASLB
Mallet Bag - Bogdan Bacanu



4STM1
Timpani Stool



4STM4
Timpani Chair "Deluxe"



PT100
Timpani Key



PBA02
Felt Timpani Muffler



Long Drop Cover	Timpani Size/Model
4TRHNPA20	20" Symphonic Generation II
4TRHNPA23	23" Symphonic Generation II
4TRHNPA26	26" Symphonic Generation II
4TRHNPA29	29" Symphonic Generation II
4TRHNPA32	32" Symphonic Generation II



Head Cover	Timpani Size/Model
4TRAPPA20	20" Symphonic Generation II
4TRAPPA23	23" Symphonic Generation II
4TRAPPA26	26" Symphonic Generation II
4TRAPPA29	29" Symphonic Generation II
4TRAPPA32	32" Symphonic Generation II



Flight Case	Timpani Size/Model
4TRFCPAPR20	20" Symphonic Generation II
4TRFCPAPR23	23" Symphonic Generation II
4TRFCPAPR26	26" Symphonic Generation II
4TRFCPAPR29	29" Symphonic Generation II
4TRFCPAPR32	32" Symphonic Generation II



Adams Musical Instruments



Koning Willem I
Award

Winner biannual award
for best national
entrepreneurship

Aziëstraat 17-19
NL-6014 DA Ittervoort
The Netherlands

P.O. Box 3514
NL-6017 ZG Thorn
The Netherlands

Phone +31 (0)475 56 0710
Fax +31 (0)475 56 3328

export@adams.nl
www.adams-music.com



[www.facebook.com
/AdamsPercussion](http://www.facebook.com/AdamsPercussion)



[www.twitter.com
/AdamsPercussion](http://www.twitter.com/AdamsPercussion)

www.adams-music.com